

WWW.ECQH.EU



2 - 11 AUGUST 2024

4TIME AQHA SHOW WITH CHAMPIONSHIP FINAL

2TIME AQHA SHOW FOR LEVEL 1

FUTURITY NSBA OF GERMANY

YOUNG HORSE CUP FOR 2 & 3 YO HORSES

CELEBRATION FOR 4 & 5 YO HORSES

PLEASURE VERSATILITY

Photo © Art & Light Design © Janna Jahnemerk

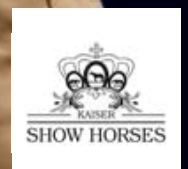

Wishing you all a great show!
European Championship 2024



**GLAMOURGIRLS
UNITED**

from...
**Glamourgirl
Loves To Lope &
Best Of Glamourgirl**

...and the Glambinis
**VS The Gladiator
Only A GlamourBoy
VS DiamondGirl**

nina

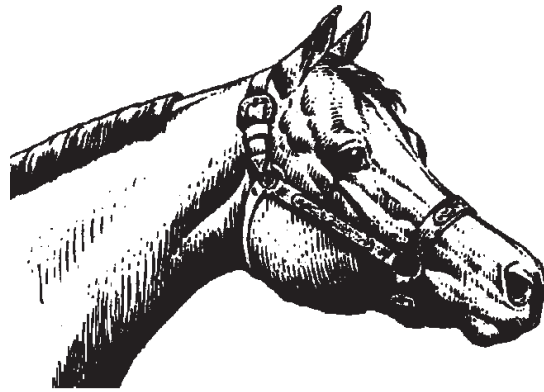

PATTERNBOOK

34th European Championship of American Quarter Horses

2. - 11. August 2024

Current Show Infos: ecqh.eu
Livestream: <https://www.equinestream.com>

AMERICAN
QUARTER
HORSE
ASSOCIATION

FEQHA
FEDERATION
OF
EUROPEAN
QUARTER
HORSE
ASSOCIATIONS



Liebe Teilnehmerinnen und Teilnehmer an der ECQH24

Ich freue mich sie zur 34. European Championship of American Quarter Horses willkommen zu heissen. Der wichtigste Wettbewerb in Europa mit der zahlenmässig grössten registrierten Pferderasse der Welt, dem American Quarter Horse. Nicht nur unsere Pferde sind einzigartig sondern auch die Zusammenarbeit der in den in der FEQHA zusammen gefassten Länderverbände (Affiliates) mit der AQHA. Die AQHA definiert die sportlichen Regeln was uns hilft die Wettkämpfe regelkonform durchzuführen. Einzig betreffend Tiererschutz und Doping gehen nationale Regeln vor. Wir setzen diese zum Schutz unserer geliebten Tiere und für die Fairness unter den Teilnehmern konsequent durch.

Wiederum bieten wir die Pleasure Versatility und den Ranch Riding Challenge für Pferde ab 6 Jahren an. Die Jugend ist nicht nur bei den Teilnehmern sondern auch bei den Pferden unsere Zukunft. Wir freuen uns deshalb auf die Pleasure und Trail Celebration für 4 und 5 jährige Pferde, den Kumlegaard Young Horse Cup für 2 und 3 jährige Pferde und die NSBA Futurity.

Diese attraktiven Zusatzshows sind nur möglich dank grosszügigem Sponsoring. Vielen Dank Kaiser Show-Horses (Celebration), Kumlegaard Quarter Horses (Young Horse Cup), AQHA, Mitgliederverbänden, Betrieben und Privatpersonen.

Herzlich willkommen in Kreuth zu einer spannenden und fairen ECQH24

**Markus Müller
Präsident FEQHA**



Dear Exhibitors of the ECQH24

I am pleased to welcome you to the 34th European Championship of American Quarter Horses. It is the most important competition in Europe with the largest registered horse breed in the world, the American Quarter Horse. Our horses are special as well as the cooperation between the FEQHA Member Associations and AQHA. AQHA defines the sporting rules, which helps organizing the competitions. Only with regard to animal welfare and doping national rules take precedence. We enforce these rules consistently to protect our beloved animals and to ensure fairness among the participants.

Again we offer the Pleasure Versatility and the Ranch Riding Challenge for horses aged 6 and over. The young is our future. Not only among the participants but also among the horses. We are therefore looking forward to the Pleasure and Trail Celebration for 4 and 5 year old horses, the Kumlegaard Young Horse Cup for 2 and 3 year old horses and the NSBA Futurity.

These attractive additional shows are only possible thanks to generous sponsorship. Many thanks to Kaiser Show-Horses (Celebration), Kumlegaard Quarter Horses (Young Horse Cup), AQHA, member associations, companies and individuals.

Welcome to Kreuth for an exciting and fair ECQH24

Markus Müller

Präsident FEQHA



Welcome Exhibitors,

The American Quarter Horse Association is honored to once again be a sponsor of the annual European Championship of American Quarter Horses. Our collaboration with the Federation of European Quarter Horse Associations underscores our unwavering dedication to promoting the American Quarter Horse across the continent.

AQHA has a presence in over 90 countries, proudly serving more than 13,500 members and over 124,000 registered American Quarter Horses in Europe.

We deeply appreciate your dedication to the American Quarter Horse and your efforts in sharing our remarkable breed, as your commitment strengthens our international equine community. We are honored to have you represent the American Quarter Horse Association at the 2024 European Championship and wish you the best of luck!

Sincerely,

A handwritten signature in black ink, appearing to read 'K. Stressman'. The signature is fluid and cursive, with a long horizontal stroke at the end.

Karl Stressman
AQHA Chief Executive Officer



PATTERN

Open	Go Round	Final
Junior Bit Reining	# 12	# 15
Hackamore/Snaffle Bit Reining	# 12	# 15
Senior Reining	# 17	# 14
Junior Ranch Riding	# 10	# 14
Senior Ranch Riding	# 9	#13
Junior Western Riding	# 3	# 7
Senior Western Riding	# 3.....	# 7

Open L1	Go Round	Final
Reining	# 11	
Ranch Riding	# 12	
Western Riding.....	L1 # 2	

Amateur	Go Round	Final
Reining	# 17	# 8
Ranch Riding	# 2	# 4
Western Riding	# 9	# 8

Amateur Select	Go Round	Final
Reining.....	# 17	# 8
Ranch Riding	# 2.....	# 4
Western Riding.....	# 9	# 8

Amateur L1	Go Round	Final
Reining	# 11	
Ranch Riding	# 12	
Western Riding	L1 # 2	

Youth	Go Round	Final
Reining	# 6	# 8
Ranch Riding	# 1.....	# 9
Western Riding	# 9	# 8

Youth L1	Go Round	Final
Reining	# 11	
Ranch Riding	# 12	
Western Riding	L1 #2	



MAIN SPONSORS OF THE ECQH 2024

FEQHA
FEDERATION
OF
EUROPEAN
QUARTER
HORSE
ASSOCIATIONS



AMERICAN
QUARTER
HORSE
ASSOCIATION





CLASS SPONSORS OF THE ECQH 2024

Senior Reining Open - 2BeRanch
Hackamore/Snaffle Bit Reining Open - 2BeRanch Stallions
Senior Western Riding Open - Bosco Mignolo Quarter Horses
Junior Trail Open - SQHA - Swiss Quarter Horse Association
Senior Trail Open - Allgäu Meadow Ranch - Ronja Schmid
Junior Western Pleasure Open - DQHA e.V. - Deutsche Quarter Horse Association
Senior Western Pleasure Open - Silver Stables
Senior Ranch Riding Open - DQHA e.V. - Deutsche Quarter Horse Association
Junior Hunter Under Saddle Open - Manuela Witt Training
Senior Hunter Under Saddle Open - Allianz Julia Köhl Pferdeversicherungen
Reining Amateur - Weingut DOM.LEANDRE-CHEVALIER - Reto Erdin
Trail Amateur - Rojo Solo Cup - Philipp Roos
Western Horsemanship Amateur - BeAllround Andrea Schmid
Western Pleasure Amateur - Mechanics N Motion - Mark Shaffer
Ranch Riding Amateur - Anna Gürlich Performance Horses
Hunter Under Saddle Amateur - Christina Gruber Performance Horses
Reining Amateur Select - Allianz Julia Köhl Pferdeversicherungen
Trail Amateur Select - Wiesinger Entsorgung
Western Riding Amateur Select - Leiner Performance Horses
Western Horsemanship Amateur Select - Gestüt Schwabing - Familie Dietzel
Western Pleasure Amateur Select - La Collezione Di Anna
Showmanship at Halter Youth - Glamourgirls United
Reining Youth - Glamourgirls United
Western Riding Youth - Glamourgirls United
Trail Youth - Glamourgirls United
Western Horsemanship Youth - Glamourgirls United
Western Pleasure Youth - Glamourgirls United
Ranch Riding Youth - Glamourgirls United
Hunter Under Saddle Youth - Glamourgirls United
Hunt Seat Equitation Youth - Glamourgirls United

FRIDAY 2.8.2024

1383 L1 GREEN TRAIL

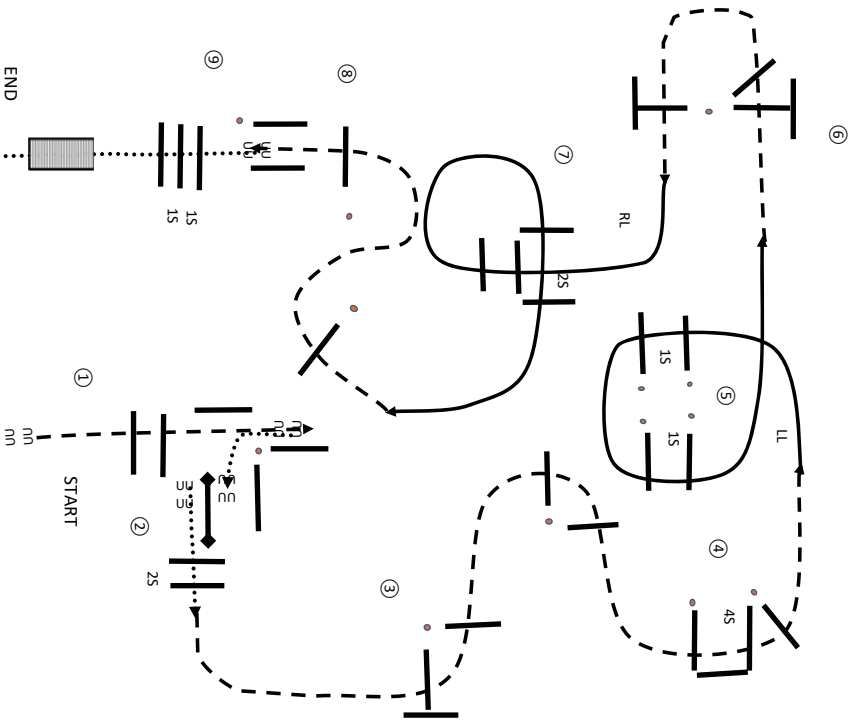

- 1 JOG OVERS INTO CHUTE-STOP-BACK TO GATE
- 2 LH GATE OPEN RIDE OVER POLE CLOSE GATE--WALK OVERS
- 3 SERPENTINE JOG OVERS
- 4 JOG OVERS
- 5 LL LOPE OVERS
- 6 JOG OVERS
- 7 RL LOPE OVERS
- 8 SERPENTINE JOG OVERS-INTO CHUTE
- 9 STOP OR BREAK TO A WALK BEFORE MARKER WALK OVERS-BRIDGE

ANNDENNISDESIGN COPYRIGHT 2024
ALL RIGHTS RESERVED

FRIDAY 2.8.2024

3380 L1 AMATEUR TRAIL
4388 L1 YOUTH TRAIL

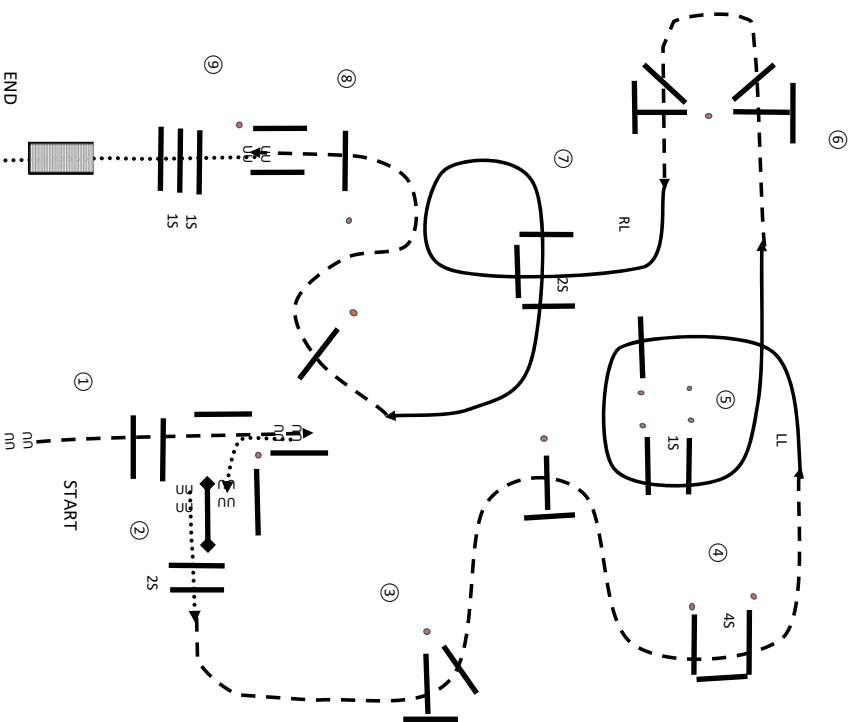

- 1 JOG OVERS INTO CHUTE-STOP-BACK TO GATE
- 2 LH GATE OPEN RIDE OVER POLE CLOSE GATE--WALK OVERS
- 3 SERPENTINE JOG OVERS
- 4 JOG OVERS
- 5 LL LOPE OVERS
- 6 JOG OVERS
- 7 RL LOPE OVERS
- 8 SERPENTINE JOG OVERS-INTO CHUTE
- 9 STOP OR BREAK TO A WALK BEFORE MARKER WALK OVERS-BRIDGE

ANNDENNISDESIGN COPYRIGHT 2024
ALL RIGHTS RESERVED

FRIDAY 2.8.2024

5220 TRAIL IN HAND YOUNG HORSE CUP

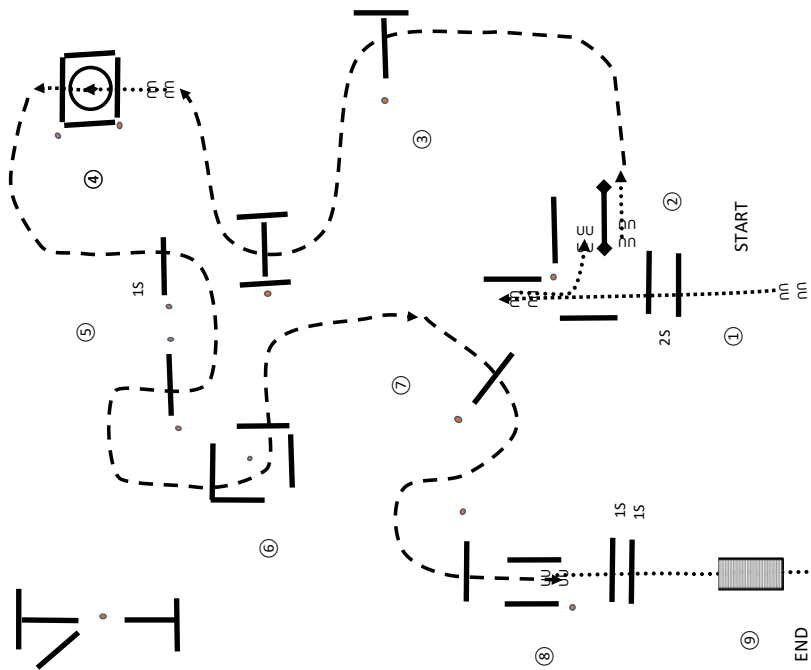

- 1 WALK OVERS INTO CHUTE-STOP-BACK TO GATE
- 2 LH GATE OPEN WALK OVER POLE CLOSE GATE--WALK A FEW STEPS-TROT
- 3 SERPENTINE TROT OVERS
- 4 STOP OR BREAK TO WALK-WALK IN BOX 360 RIGHT-WALK OVER
- 5 SERPENTINE TROT OVERS
- 6 TROT THROUGH BOX AROUND CONE
- 7 SERPENTINE TROT OVERS
- 8 TROT OVER INTO CHUTE-STOP OR BREAK TO A WALK BEFORE MARKER- WALK OVERS
- 9 BRIDGE

ANNDENNISDESIGN COPYRIGHT 2024
ALL RIGHTS RESERVED

END OF PATTERN

FRIDAY 2.8.2024

1394 L1 GREEN RANCH TRAIL OPEN

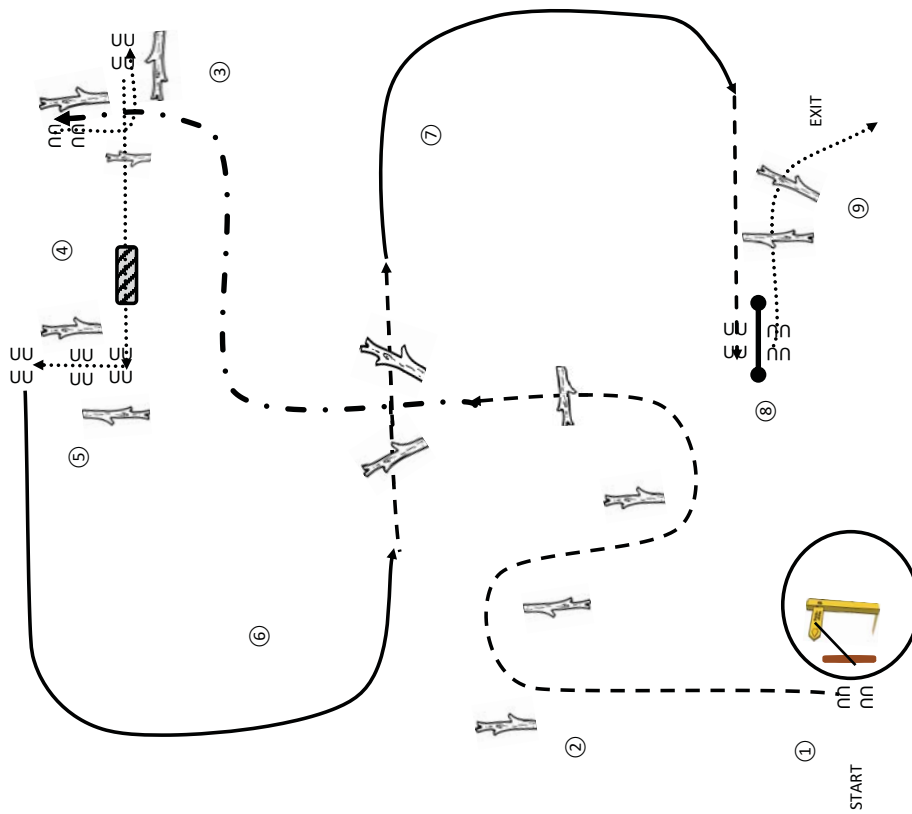

- 1 PICK UP ROPE-DALLY-UNDALLY-HANG ROPE BACK UP-DO NOT DRAG LOG
- 2 TROT RIGHT CIRCLE-CONTINUE TROTTING
- 3 TROT SERPENTINE AROUND AND OVER LOG
- 4 EXTENDED TROT IN BETWEEN LOGS AND INTO CHUTE-STOP-BACK L
- 5 WALK OVER LOG- BRIDGE
- 6 STOP-SIDEPASS IN BETWEEN LOGS
- 7 LL LOPE-BREAK TO TROT OVER LOGS
- 8 WORK GATE
- 9 WALK OVER LOGS TO EXIT

ANNDENNISDESIGN COPYRIGHT 2024
ALL RIGHTS RESERVED

MONDAY 5.8.2024

1381 EC JUNIOR TRAIL

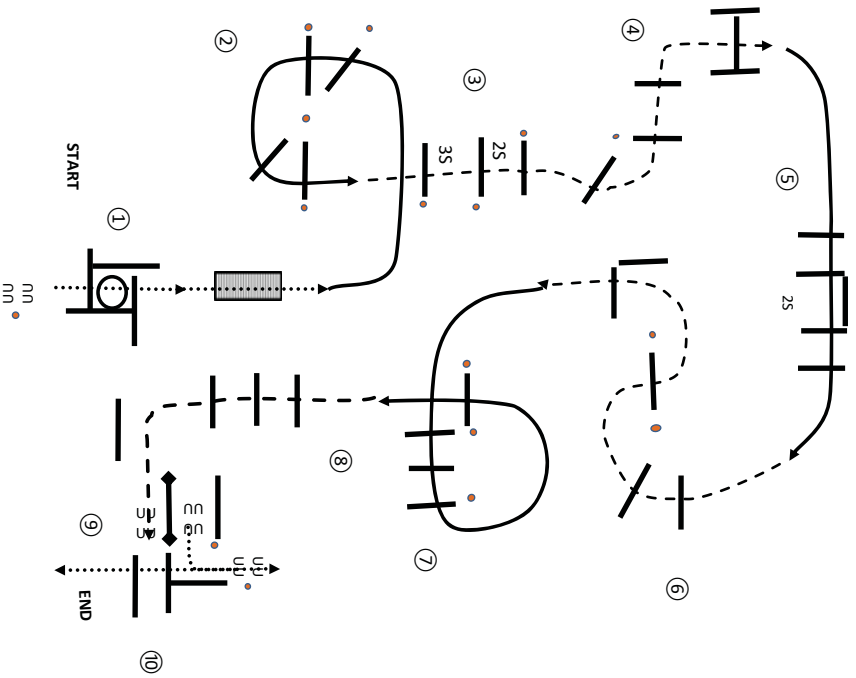

- 1 WALK OVER INTO BOX-360 EITHER WAY-WALK OVER-BRIDGE
- 2 LL LOPE OVERS
- 3 JOG OVERS
- 4 JOG OVER
- 5 RL LOPE OVERS-BREAK TO A JOG
- 6 SERPENTINE JOG OVERS
- 7 LL LOPE OVERS-BREAK TO A JOG
- 8 JOG OVERS TO GATE
- 9 STOP-LH GATE OPEN RIDE THROUGH CLOSE-BACK L
- 10 WALK OVERS

END OF PATTERN

ANNDENNISDESIGN COPYRIGHT 2024
ALL RIGHTS RESERVED

MONDAY 5.8.2024

2380 EC AMATEUR TRAIL
2388 EC AMATEUR SELECT TRAIL

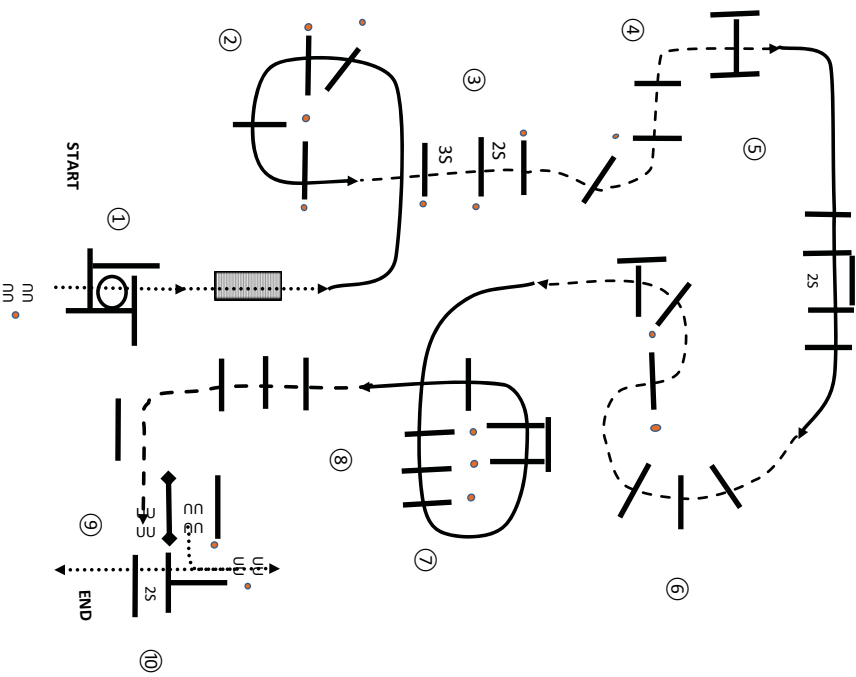

- 1 WALK OVER INTO BOX-360 EITHER WAY-WALK OVER-BRIDGE
- 2 LL LOPE OVERS
- 3 JOG OVERS
- 4 JOG OVER
- 5 RL LOPE OVERS-BREAK TO A JOG
- 6 SERPENTINE JOG OVERS
- 7 LL LOPE OVERS-BREAK TO A JOG
- 8 JOG OVERS TO GATE
- 9 STOP-LH GATE OPEN RIDE THROUGH CLOSE-BACK L
- 10 WALK OVERS

END OF PATTERN

ANNDENNISDESIGN COPYRIGHT 2024
ALL RIGHTS RESERVED

WEDNESDAY 7.8.2024

4380 EC YOUTH TRAIL
5002 NSBA OPEN FUTURITY TRAIL

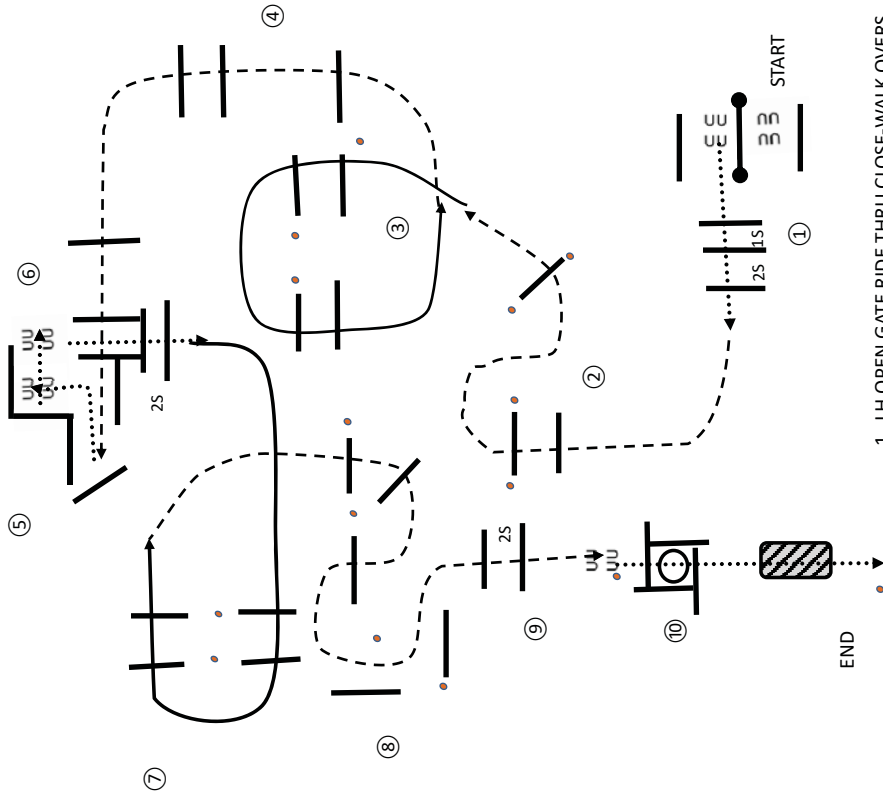

- 1 LH OPEN GATE RIDE THRU CLOSE-WALK OVERS
 - 2 SERPENTINE JOG OVERS
 - 3 LL LOPE OVERS
 - 4 JOG OVERS-INTO CHUTE-STOP
 - 5 BACK L-SIDEPASS
 - 6 WALK OVERS
 - 7 RL LOPE OVERS
 - 8 BREAK TO JOG-JOG OVERS AROUND CONE
 - 9 JOG OVERS
 - 10 STOP OR BREAK TO A WALK-WALK IN BOX-360 EITHER WAY
- WALK OVER-BRIDGE-END OF PATTERN

AN DENNIS DESIGN COPYRIGHT 2024
ALL RIGHTS RESERVED

WEDNESDAY 7.8.2024

1382 EC SENIOR TRAIL

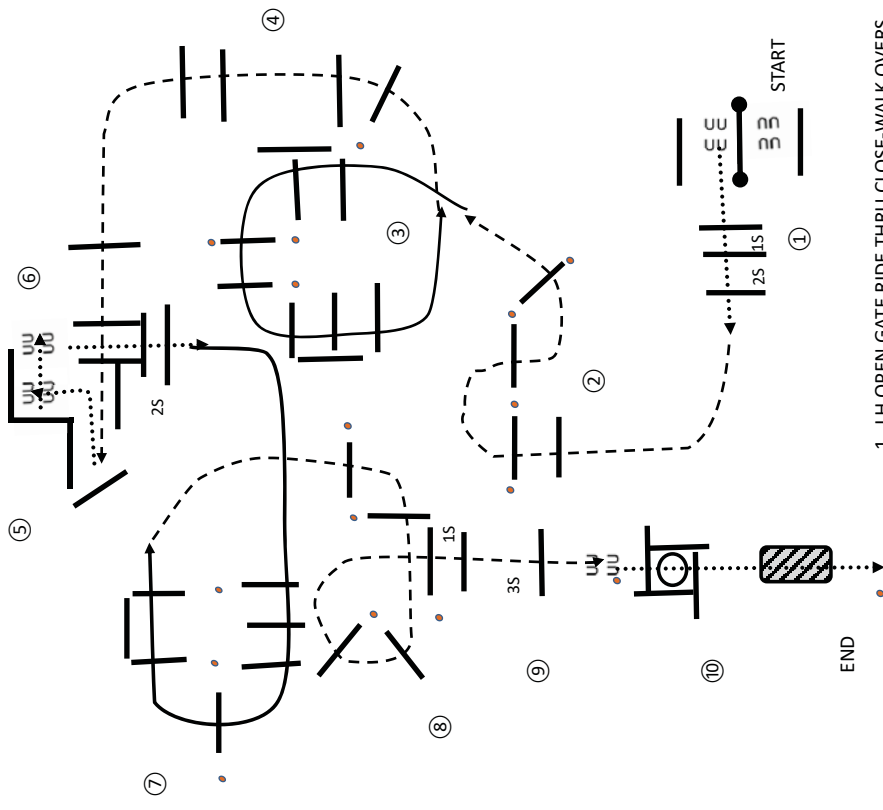

- 1 LH OPEN GATE RIDE THRU CLOSE-WALK OVERS
 - 2 SERPENTINE JOG OVERS
 - 3 LL LOPE OVERS
 - 4 JOG OVERS-INTO CHUTE-STOP
 - 5 BACK L-SIDEPASS
 - 6 WALK OVERS
 - 7 RL LOPE OVERS
 - 8 BREAK TO JOG-JOG OVERS AROUND CONE
 - 9 JOG OVERS
 - 10 STOP OR BREAK TO A WALK-WALK IN BOX-360 EITHER WAY
- WALK OVER-BRIDGE-END OF PATTERN

AN DENNIS DESIGN COPYRIGHT 2024
ALL RIGHTS RESERVED

THURSDAY 8.8.2024

1390 EC OPEN RANCH TRAIL
2380 EC AMATEUR RANCH TRAIL

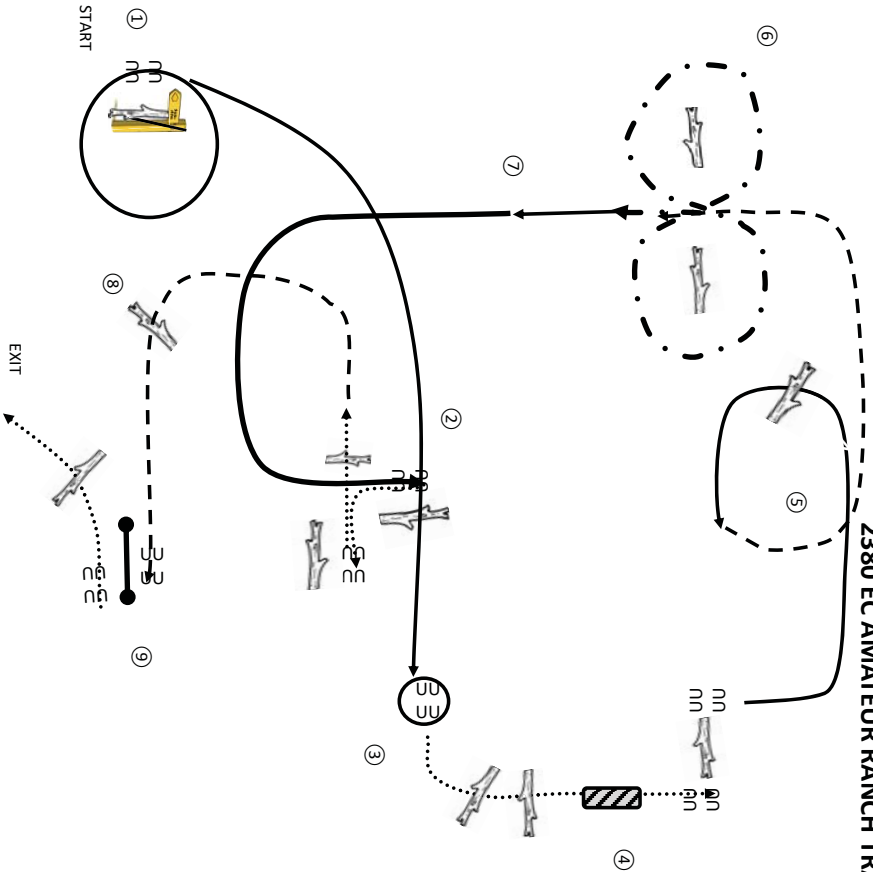

- 1 LOG DRAG RIGHT-WALK OR TROT RIGHT CIRCLE-BRING LOG BACK TO START
- 2 RL LOPE OVER LOG
- 3 STOP-360 EITHER WAY-WALK OVERS
- 4 BRIDGE-STOP-SIDE PASS LOG-TROT OUT
- 5 LL LOPE OVER LOG-BREAK TO TROT-TROT TO CENTER OPENING
- 6 EXTEND THE TROT FIGURE 8 AROUND THE LOGS
- 7 LL LOPE- EXTENDED LL LOPE INTO CHUTE-STOP-BACK L-WALK OVER
- 8 TROT OVER LOG TO GATE-STOP
- 9 WORK GATE-DISMOUNT LEAD HORSE OVER LOG TO EXIT

ANNDENNISDESIGN COPYRIGHT 2024
ALL RIGHTS RESERVED

FRIDAY 9.8.2024

1381 FINALE JUNIOR TRAIL
4380 FINALE YOUTH TRAIL

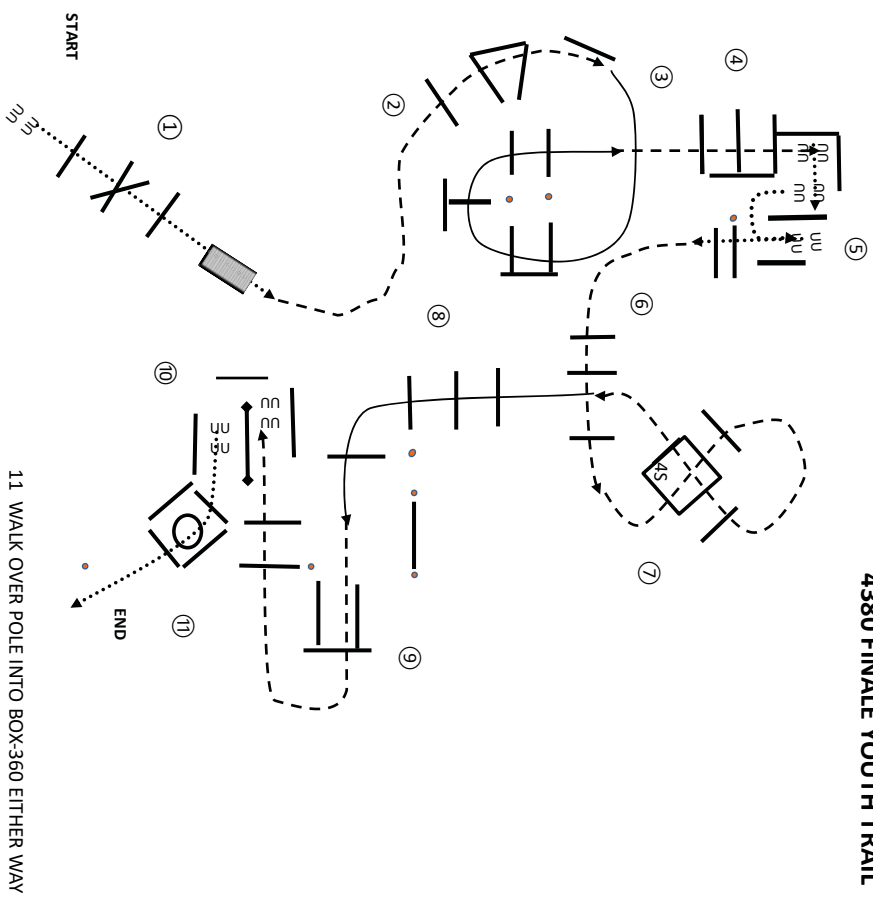

- 1 WALK OVERS-BRIDGE
- 2 JOG OVERS
- 3 RL LOPE OVERS
- 4 BREAK TO A JOG-JOG OVERS-STOP-SIDE PASS RIGHT
- 5 BACK U OUT CHUTE AROUND CONE INTO 2ND CHUTE-WALK OVERS
- 6 JOG OVERS
- 7 SERPENTINE JOG OVERS
- 8 LL LOPE OVERS
- 9 BREAK TO JOG-JOG OVERS TO GATE-STOP
- 10 LH GATE OPEN WALK OVER POLE-CLOSE
- 11 WALK OVER POLE INTO BOX-360 EITHER WAY
WALK OVER - END OF PATTERN

ANNDENNISDESIGN COPYRIGHT 2024
ALL RIGHTS RESERVED

1382 FINALE SENIOR TRAIL

FRIDAY 9.8.2024

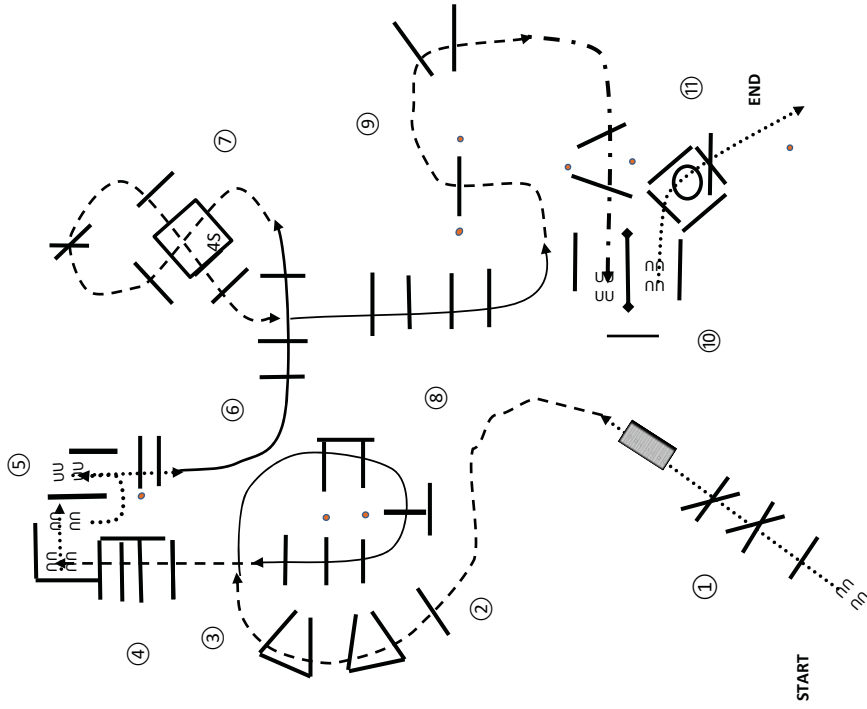

- 1 WALK OVERS-BRIDGE
- 2 JOG OVERS
- 3 RL LOPE OVERS
- 4 BREAK TO A JOG-JOG OVERS-STOP-SIDE PASS RIGHT
- 5 BACK U OUT CHUTE AROUND CONE INTO 2ND CHUTE-WALK OVERS
- 6 LL LOPE OVERS-BREAK TO JOG
- 7 SERPENTINE JOG OVERS
- 8 LL LOPE OVERS
- 9 BREAK TO JOG-JOG OVER 3 POLES-EXTENDED TROT OVER 2 POLES TO GATE-STOP
- 10 LH GATE OPEN WALK OVER POLE-CLOSE
- 11 WALK OVER POLE INTO BOX-360 EITHER WAY
WALK OUT OVER X-END OF PATTERN

ANNDENNISDESIGN COPYRIGHT 2024
ALL RIGHTS RESERVED

2380 FINALE AMATEUR TRAIL
2388 FINALE AMATEUR SELECT

FRIDAY 9.8.2024

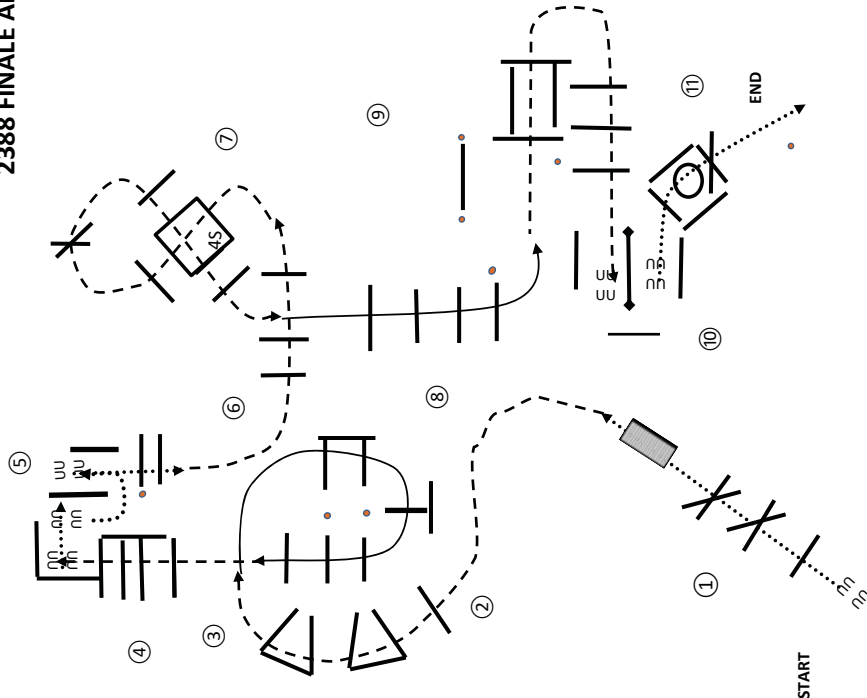

- 1 WALK OVERS-BRIDGE
- 2 JOG OVERS
- 3 RL LOPE OVERS
- 4 BREAK TO A JOG-JOG OVERS-STOP-SIDE PASS RIGHT
- 5 BACK U OUT CHUTE AROUND CONE INTO 2ND CHUTE-WALK OVERS
- 6 JOG OVERS
- 7 SERPENTINE JOG OVERS
- 8 LL LOPE OVERS
- 9 BREAK TO JOG-JOG OVERS TO GATE-STOP
- 10 LH GATE OPEN WALK OVER POLE-CLOSE
- 11 WALK OVER POLE INTO BOX-360 EITHER WAY
WALK OUT OVER X-END OF PATTERN

ANNDENNISDESIGN COPYRIGHT 2024
ALL RIGHTS RESERVED

SATURDAY 10.8.2024

1390 FINALE RANCH TRAIL OPEN

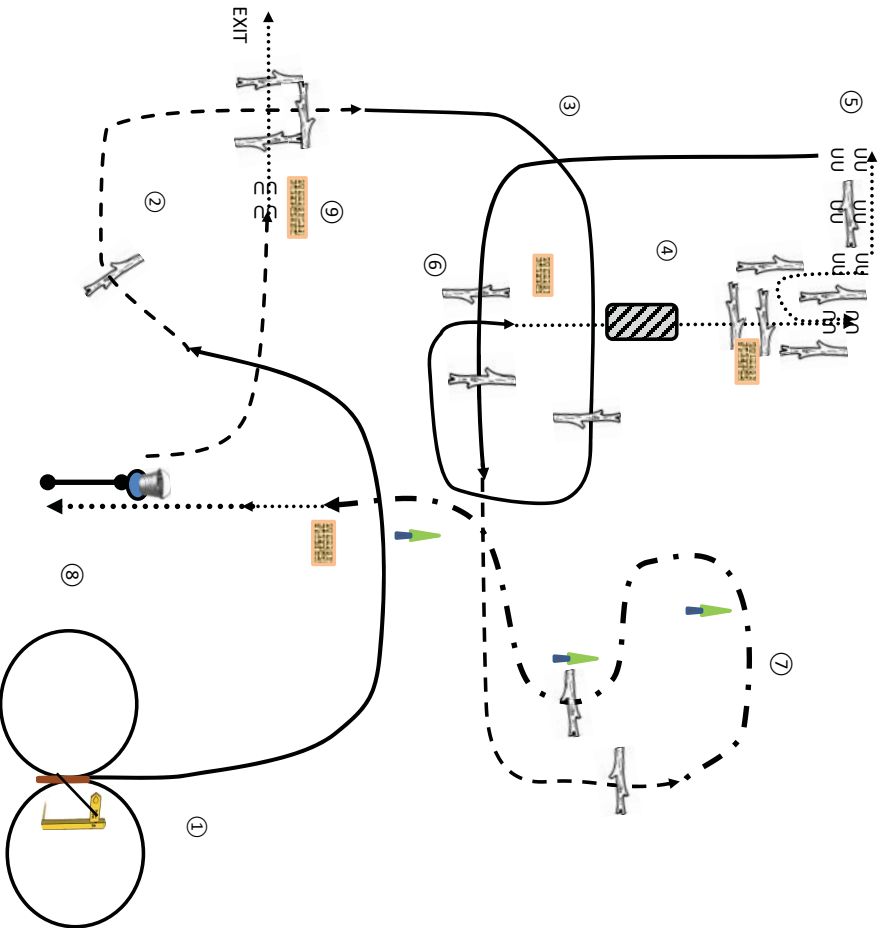

- 1 DRAG LOG FIGURE 8 AT WALK OR TROT-BRING LOG BACK TO START-HANG ROPE
- 2 LL LOPE-BREAK TO TROT-TROT OVER LOGS
- 3 RL LOPE OVER LOG-BREAK TO A **WALK-DO NOT STOP**
- 4 WALK OVER BRIDGE AND LOGS INTO CHUTE-STOP-BACK U INTO 2ND CHUTE
- 5 SIDE PASS LOG-LL LOPE OUT
- 6 LL LOPE OVER LOGS-BREAK TO TROT
- 7 TROT OVER 1 LOG-**EXTENDED** TROT SERPENTINE OVER 1 LOG
- 8 **BREAK TO WALK-DO NOT STOP-EXTENDED** WALK TO GATE-STOP-WORK GATE-PICK UP BUCKET AND CARRY
- 9 TROT OUT FROM GATE-STOP-PLACE BUCKET ON HAY BALE- DISMOUNT-LEAD HORSE OVER LOGS-WALK OUT TO EXIT

ANNDENNISDESIGN COPYRIGHT 2024
ALL RIGHTS RESERVED

SATURDAY 10.8.2024

2390 FINALE RANCH TRAIL AMATEUR

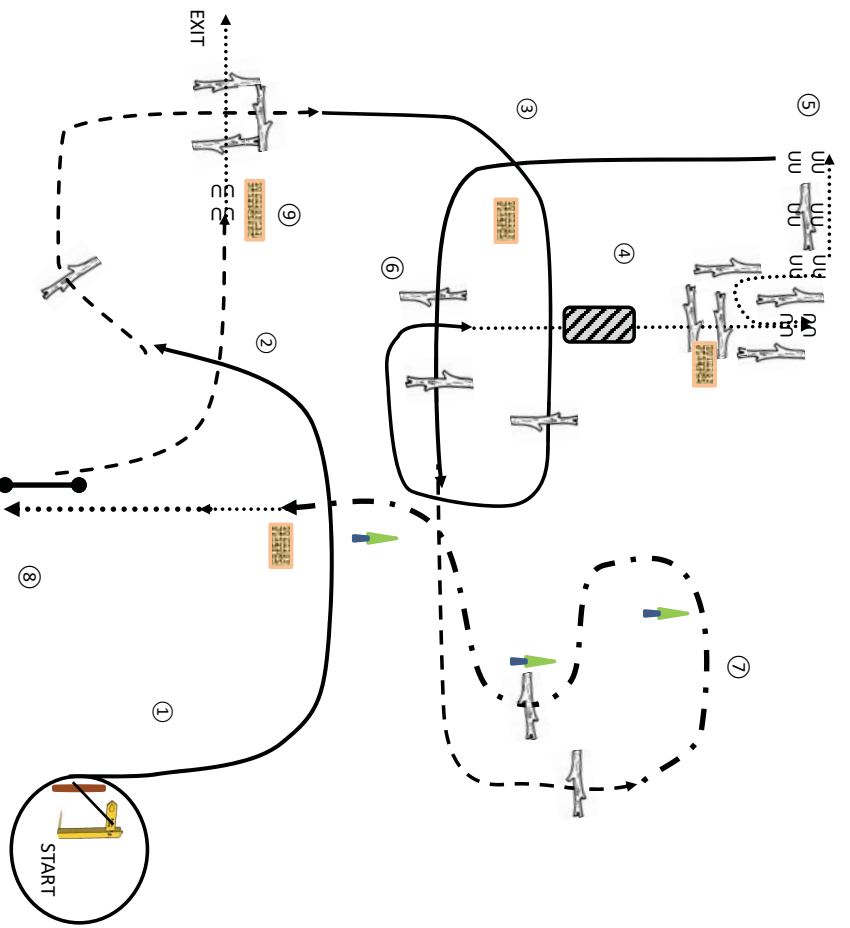

- 1 DRAG LOG RIGHT CIRCLE AT WALK OR TROT-BRING LOG BACK TO START-HANG ROPE
- 2 LL LOPE-BREAK TO TROT-TROT OVER LOGS
- 3 RL LOPE OVER LOG-BREAK TO A **WALK-DO NOT STOP**
- 4 WALK OVER BRIDGE AND LOGS INTO CHUTE-STOP-BACK U INTO 2ND CHUTE
- 5 SIDE PASS LOG-LL LOPE OUT
- 6 LL LOPE OVER LOGS-BREAK TO TROT
- 7 TROT OVER 1 LOG-**EXTENDED** TROT SERPENTINE OVER 1 LOG
- 8 **BREAK TO WALK-DO NOT STOP-EXTENDED** WALK TO GATE-STOP-WORK GATE
- 9 TROT OUT FROM GATE-STOP- DISMOUNT-LEAD HORSE OVER LOGS-WALK OUT TO EXIT

ANNDENNISDESIGN COPYRIGHT 2024
ALL RIGHTS RESERVED

SATURDAY 10.8.2024

1381 TRAIL CELEBRATION OPEN

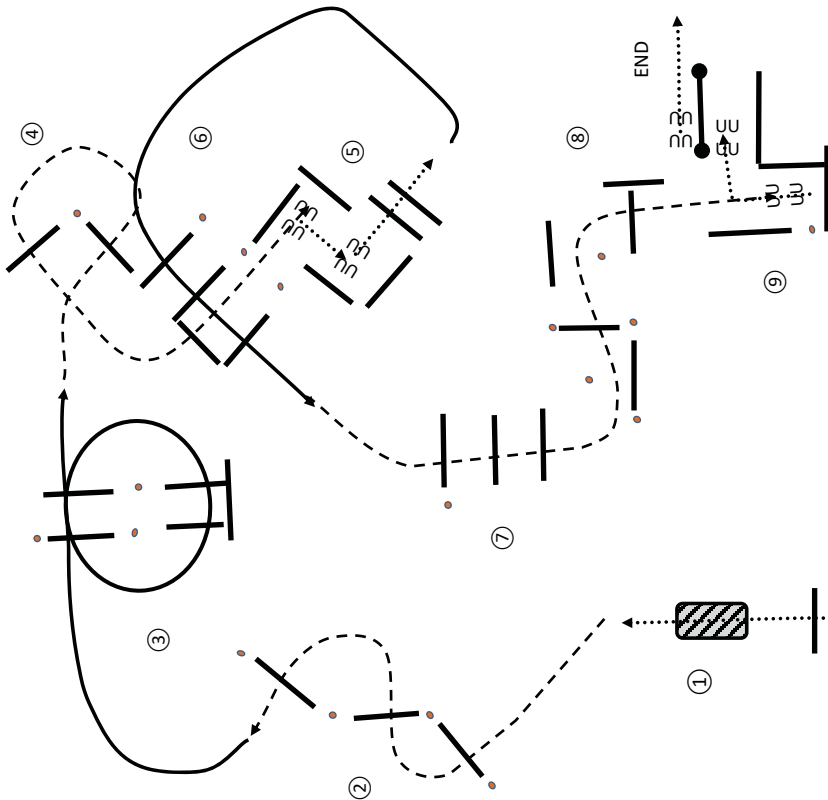

- 1 WALK OVERS-BRIDGE
- 2 SERPENTINE JOG OVERS
- 3 RL LOPE OVERS
- 4 JOG OVERS INTO BOX-STOP
- 5 SIDE PASS RIGHT-WALK OVERS
- 6 LL LOPE OVERS
- 7 JOG OVERS
- 8 SERPENTINE AROUND CONES OVER POLE INTO CHUTE- STOP
- 9 BACK TO GATE-RH GATE OPEN RIDE THROUGH CLOSE END OF PATTERN

ANNDENNISDESIGN COPYRIGHT 2024
ALL RIGHTS RESERVED

5600 Ranch Riding Challenge

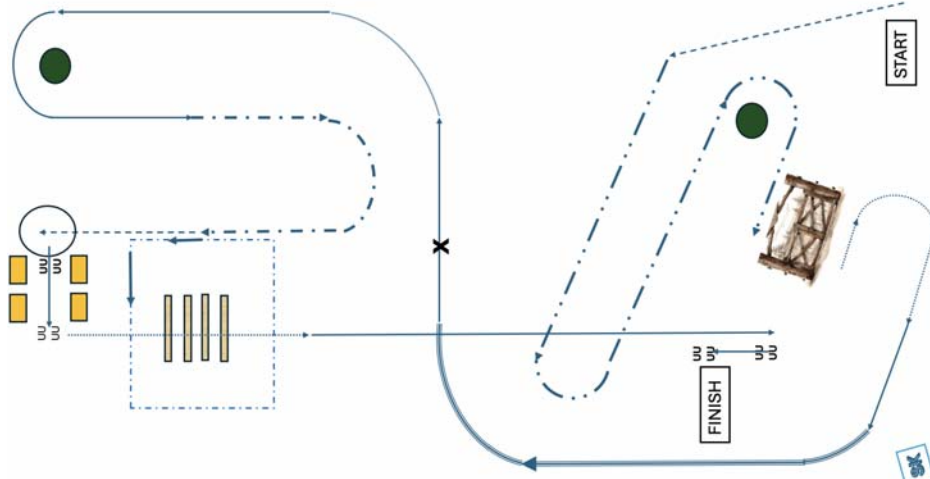

1. Trot
 2. Extended trot serpentine and up to gate, stop
 3. Work gate
 4. Collected right lead lope, extended lope, collected right lead
 5. Change leads (simple or flying)
 6. Left lead lope
 7. Extended trot
 8. Trot square around logs, trot, stop
 9. 1 1/2 turn left or right
 10. Sidepass to the right
 11. Walk and walk over logs
 12. Lope right lead up to gate
 13. Stop and back up
- Pattern completed

Amateur L1 Showmanship
Youth L1 Showmanship

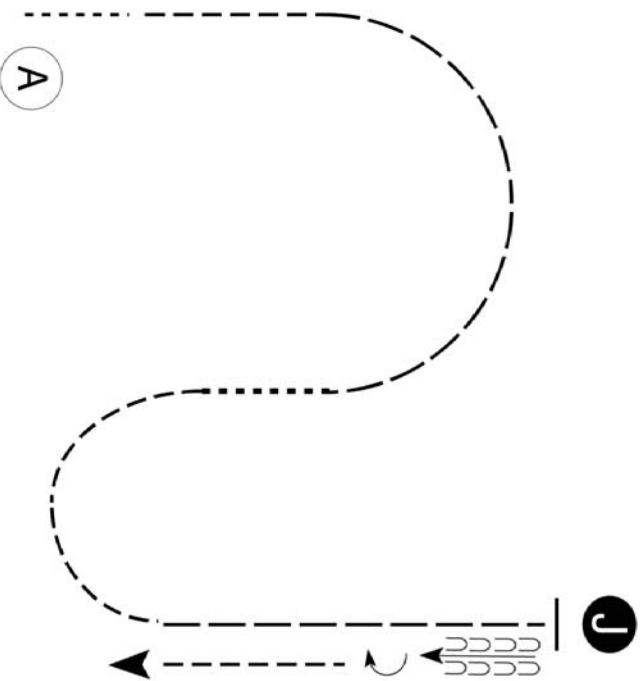

- Be ready at A.
1. Walk FORWARD two horse lengths then trot.
 2. Extended trot half circle.
 3. Walk FORWARD one horse length.
 4. Trot in a half circle.
 5. Extended trot to Judge and stop.
 6. Set up.
 7. Inspection.
 8. When dismissed, back approximately two horse lengths.
 9. Perform a 180 degree turn and trot to exit.

Kumlegaard Young Horse Cup Showmanship

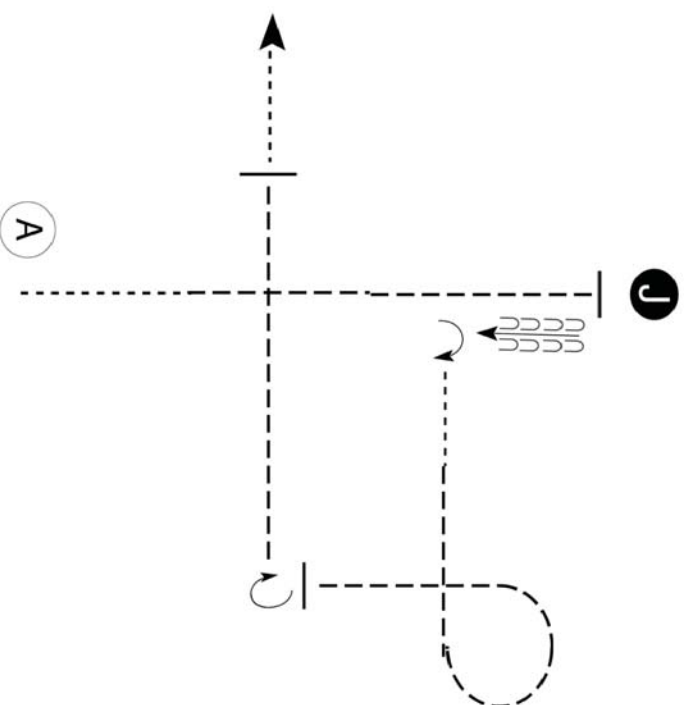

- Be ready at A.
1. Walk 1/3 of line then trot to Judge.
 2. Stop and set up.
 3. Inspection.
 4. When dismissed, back approximately a horse length.
 5. Perform a 1/4 turn.
 6. Walk, then trot straight and trot a tight 3/4 circle.
 7. Stop and perform a 1/4 turn.
 8. Trot a straight line until you cross your original line and stop.
 9. Briefly st up and present horse (do not cross sides). Walk to exit.

Amateur / Select Showmanship Go Round
Youth Showmanship Go Round

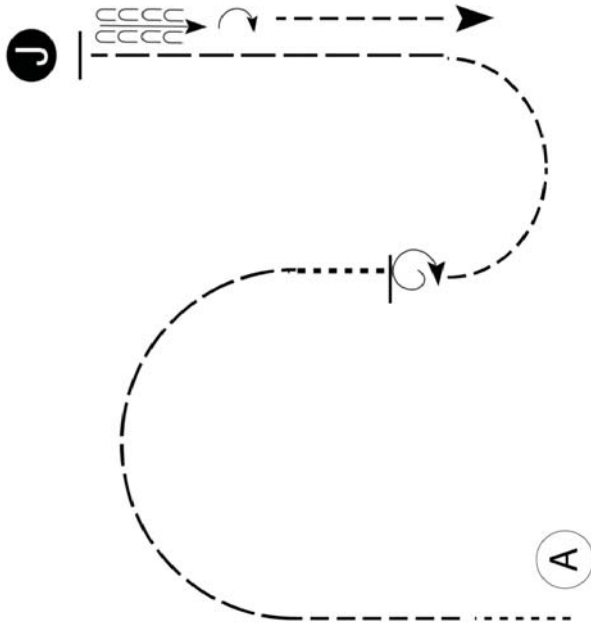

- Be ready at A.
1. Walk FORWARD two horse lengths then trot.
 2. Extended trot half circle.
 3. Walk FORWARD one horse length.
 4. Stop and perform a full turn.
 5. Trot in a half circle.
 6. Extended trot to Judge and stop.
 7. Set up.
 8. Inspection.
 9. When dismissed, back approximately two horse lengths.
 10. Perform a 180 degree turn and trot to exit.

Amateur / Select Showmanship Final
Youth Showmanship Final

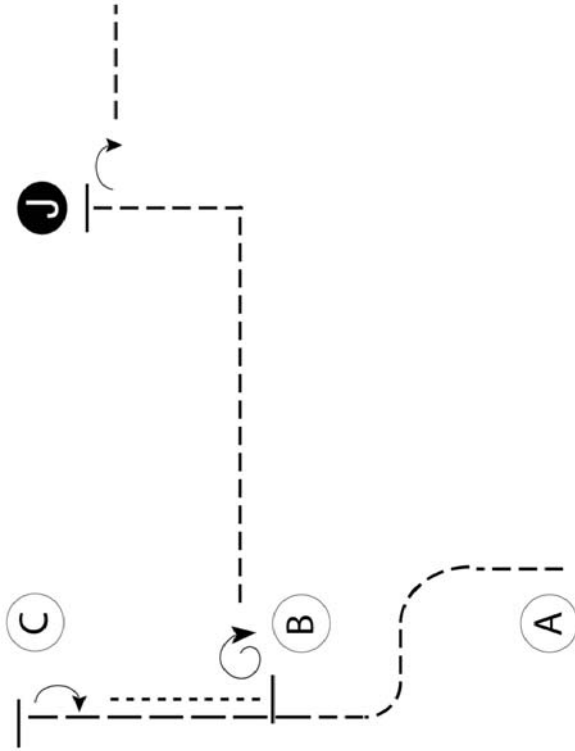

- Be ready at A.
1. Trot from A until even with B. Then, extend the trot to C and stop.
 2. Perform a 180 degree turn.
 3. Walk with forward motion until just before B.
 4. Perform a 270 degree turn.
 5. Trot a square corner to Judge.
 6. Set Up.
 7. Inspection.
 8. When dismissed, perform a 90 degree turn and pattern is complete.

Amateur L1 Western Horsemanship
Youth L1 Western Horsemanship

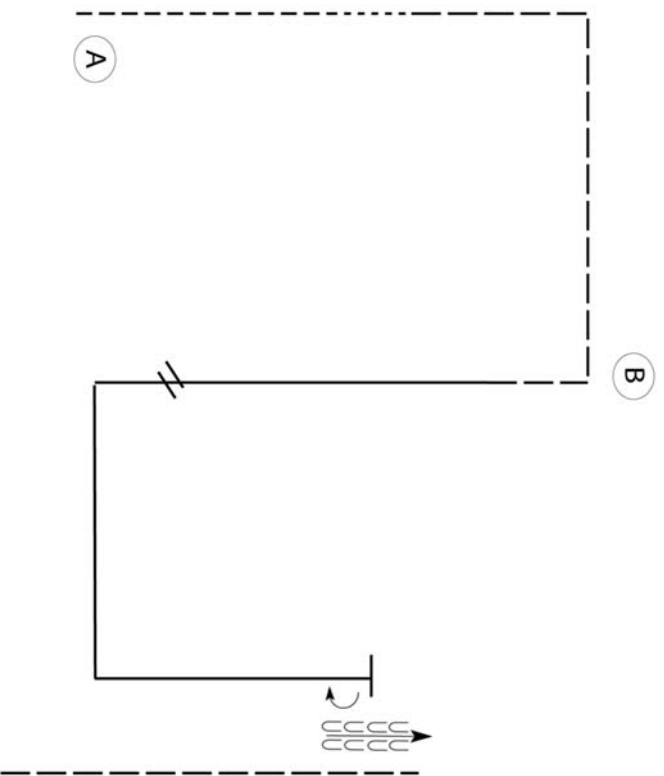

- Be ready at A.
1. Jog from A. Break to the walk and walk FORWARD 2 strides (crawling will be a minus maneuver).
 2. Extended jog two square corners.
 3. Lope on the right lead.
 4. Perform a simple lead change before even with A.
 5. Lope left lead two square corners.
 6. Stop and perform a 180 degree turn right then back approximately one horse length.
 7. Jog to exit.

Amateur / Select Western Horsemanship Go Round
Youth Western Horsemanship Go Round

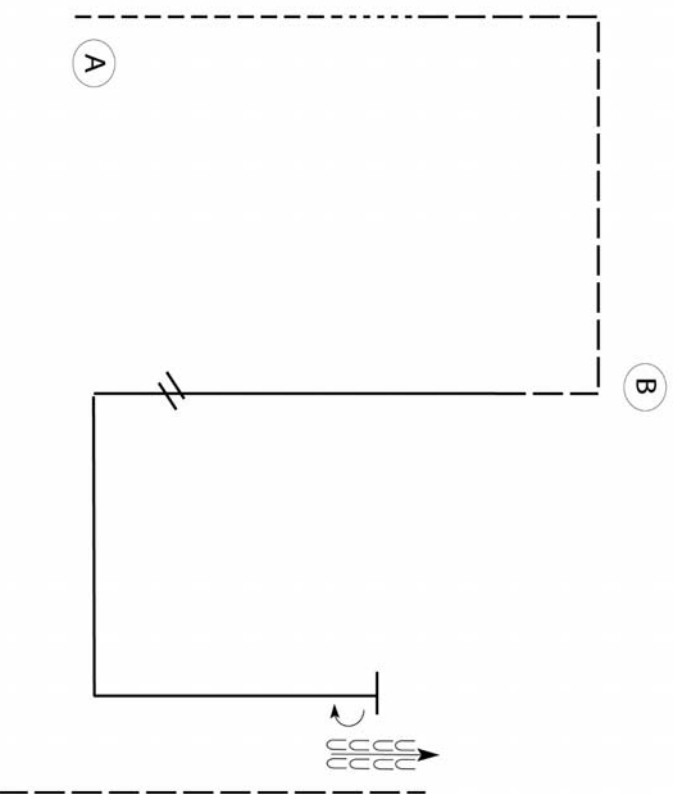

- Be ready at A.
1. Jog from A. Break to the walk and walk FORWARD 2 strides (crawling will be a minus maneuver).
 2. Extended jog two square corners.
 3. Lope on the right lead.
 4. Change leads before even with A.
 5. Lope left lead two square corners.
 6. Stop and perform a rollback right then back approximately one horse length.
 7. Extended jog to exit.

Amateur / Select Western Horsemanship Final
Youth Western Horsemanship Final

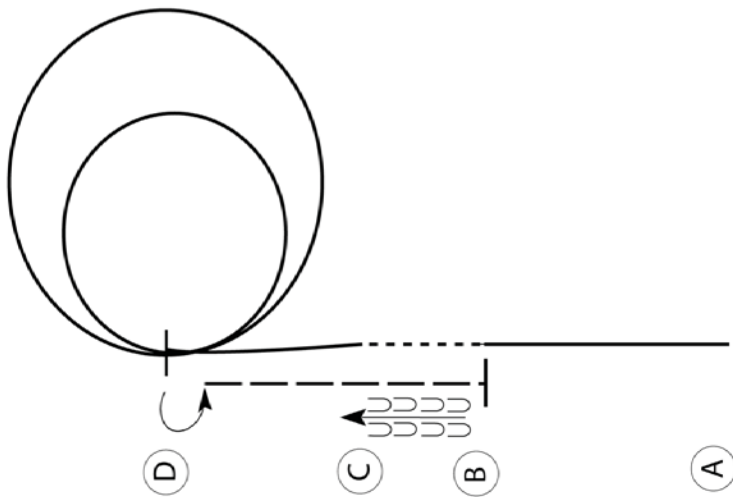

- Be ready at A.
1. Lope on the left lead to B.
 2. Walk B to C.
 3. Lope on the right lead to D.
 4. Lope a large fast circle to the right.
 5. Lope a small slow circle to the right.
 6. Stop at D and perform a 180 degree spin to the left.
 7. Extend the jog to B.
 8. Stop at B and back to C.

Amateur L1 Hunt Seat Equitation
Youth L1 Hunt Seat Equitation

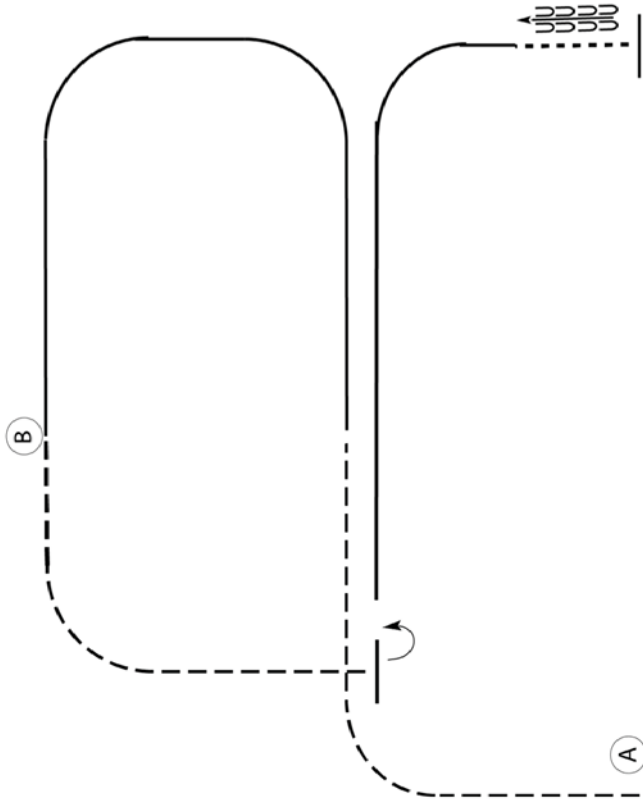

- Be ready at A.
1. Sitting trot for approximately 3 strides
 2. Trot on the left diagonal to center of pattern.
 3. Canter on the left lead to B.
 4. Trot on the right diagonal until halfway to A.
 5. Stop and perform a 90 degree turn on the forehead to the left to change direction.
 6. Canter on the right lead around corner.
 7. Forward walk until even with A.
 8. Stop and back.

Amateur Hunt Seat Equitation Go Round
Youth Hunt Seat Equitation Go Round

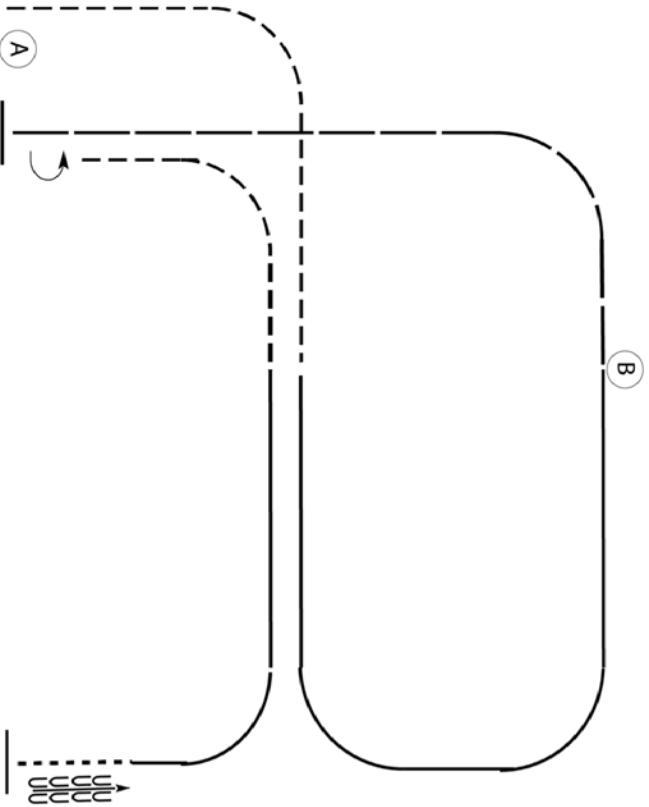

1. Trot on the left diagonal to center of pattern.
2. Canter on the left lead to B.
3. Hand gallop until even with A and stop.
4. Perform a 180 degree turn on the forehand to the left to change direction.
5. Sitting trot to center of pattern.
6. Canter on the right lead around corner.
7. Forward walk until even with A.
8. Stop and back.

Amateur Hunt Seat Equitation Final
Youth Hunt Seat Equitation Final

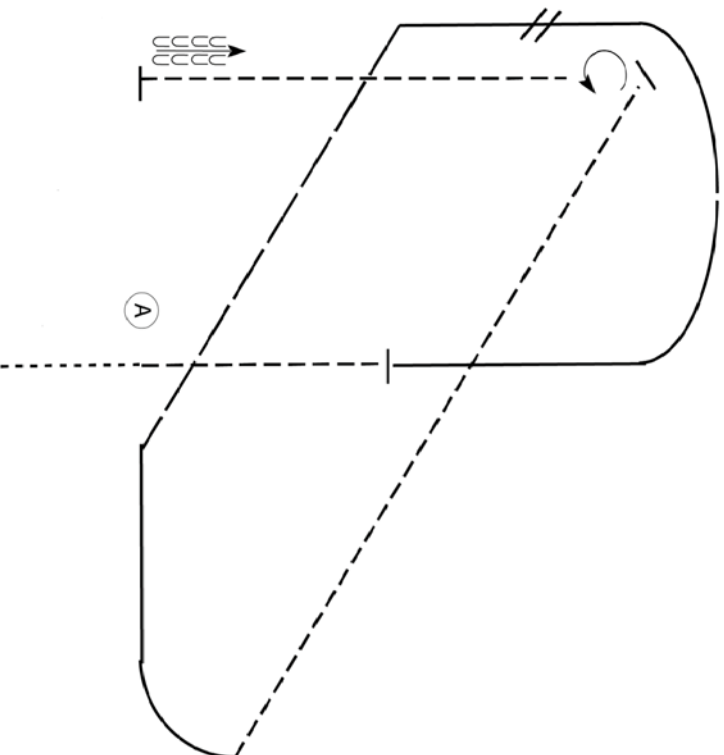

- Be ready before A.
1. Walk to A. Left diagonal trot then halt for 3 seconds.
 2. Right lead counter canter in half circle.
 3. Change leads.
 4. Left lead straight then hand gallop on diagonal.
 5. Left lead canter around corner.
 6. Right diagonal trot half the line then 2 point the trot.
 7. Halt and perform a forehand turn left to change direction. Sitting trot until even with A.
 8. Halt and back approximately 2 horse length.



JOINTLY

CHIROPRAKTIK IN DER TIERMEDIZIN

Die non-invasive Behandlungsmethode, um die Leistungsfähigkeit Ihres Pferdes auf natürliche Weise zu optimieren. Denn nur ein gut funktionierendes Nervensystem kann Muskeln und Bänder perfekt koordinieren und maximale Leistungsfähigkeit garantieren. Für mehr Beweglichkeit, Kraft und Leistung.

Buchen Sie jetzt einen Behandlungstermin vor Ort - bei der Tierärztin und IAVC-zertifizierten Tierchiropraktikerin Leonie Feil:

E-Mail: leonie.feil@jointly.vet

Mobil: +49 172 721 9594

WWW.JOINTLY.VET